

Low-profile 6.4mm height contributes to flexibility in set design



Typical Specifications

Items		Specifications
Rating (max.) (Resistive load)		10mA 5V DC
Contact resistance	8-direction	500mΩ max.
	Center-push	
Operating angle (8-direction)		Each direction 12° ±3°
Travel (Center-push)		0.2±0.1 mm
Operating life	Total with 8-direction	100,000 cycles
	Center-push	100,000 cycles

Product Line

Product No.	Maximum resolution	Operating force		Minimum order unit (pcs.)	
		Direction	Center-push	Japan	Export
RKJXL100401V	8	10±7mN·m	4.5±1N	800	1,600

Packing Specifications

Tray

Number of packages (pcs.)		Export package measurements (mm)
1 case / Japan	1 case / export packing	
800	1,600	532×379×167

Dimensions

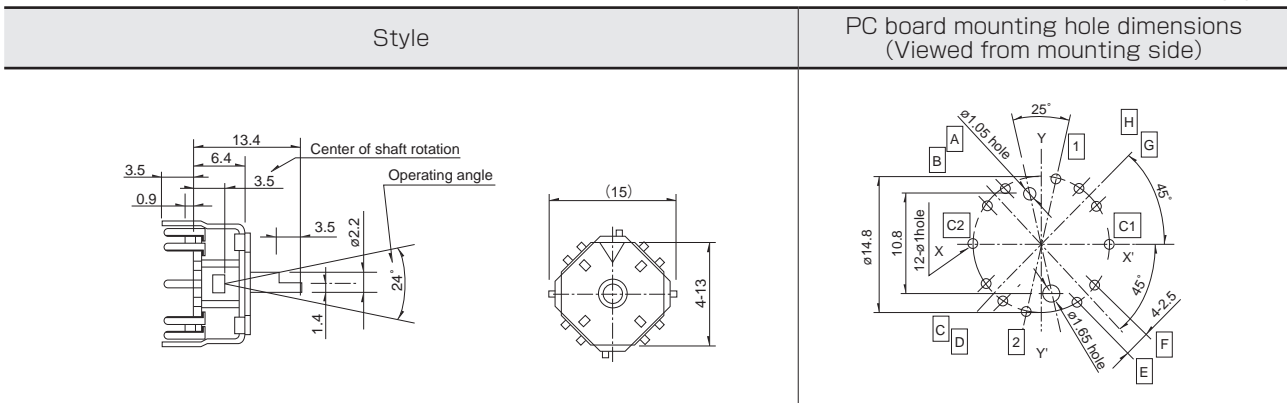

Output Relation Chart Between Lever Position and ON Position.







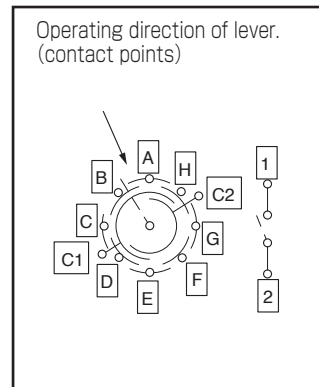

Terminal The direction of the operation	A	B	C	D	E	F	G	H	C1	C2	1	2
A	ON								ON			
B		ON							ON			
C			ON						ON			
D				ON					ON			
E					ON					ON		
F						ON				ON		
G							ON			ON		
H								ON		ON		
Center Push											ON	ON

Operating direction of lever.

※ Shorting areas exist between adjacent terminals
 ※ Between H and A, and D and E, both C1 and C2 are connected

Circuit Diagram



Type		Switch type			
Series		RKJXT1F	RKJXM	RKJXW	RKJXL
Photo					
Dimensions (mm)	W	17	11	36	13
	D			48.5	
	H	10.5	6.6	26.5	6.4
Shaft material		Metal			
Directional resolution		4-direction	8-direction		
Directional operating feeling (tactile feeling)		With			Without
Lever return mechanism		With			
Center-push switch		With			
Encoder		With	Without	With	Without
Operating temperature range		-40°C to +85°C			-30°C to +70°C
Operating life	Directional operation	Total with 4-direction 50,000 cycles	Total with 8-direction 100,000 cycles	30,000 cycles for each direction	8 directions total: 100,000 cycles
	Center-push			30,000 cycles	100,000 cycles
	Encoder	15,000 cycles	—	30,000 cycles	—
Automotive use		●	●	●	●
Life cycle (availability)					
Rating (max.) (Resistive load)		10mA 5V DC			
Electrical performance	Output voltage	—	—	—	—
	Encoder resolution	15pulses/360°	—	15pulses/360°	—
	Insulation resistance	100MQ min. 250V DC			
	Voltage proof	250V AC for 1min.		360V AC for 2s	300V AC for 1min. or 360V AC for 2s
Mechanical performance	Directional operating force	40±25mN·m	Direction A, B, C, D 30±20mN·m	2.5±1.5N	10±7mN·m
			Direction AB, BC, CD, DA 25±20mN·m		
	Push operating force	5±2N	3±1.5N		4.5±1N
	Encoder detent torque	15±8mN·m	—	30±20mN·m	—
	Terminal strength	5N for 1min.			
Actuator strength	Push / pull directions	100N (Push/Pull)	100N (Push), 50N (Pull)	100N (Push)	100N (Push), 50N (Pull)
	Operating direction	0.4N·m	0.3N·m	50N	100N
Environmental performance	Cold	-40°C 500h			
	Dry heat	85°C 500h			
	Damp heat	60°C, 90 to 95%RH 500h			
Page		398	400	402	404

Switch Type Multi Control Devices Soldering Conditions 412
Switch Type Multi Control Devices Cautions 413

Note

● Indicates applicability to all products in the series.

Reference for Manual Soldering

Series	Tip temperature	Soldering time	No. of solders
RKJXT1F, RKJXM, RKJXL, SLLB, SLLB5, SRBE, SKRH	350±5°C	3s max.	1 time

Reference for Dip Soldering

Series	Preheating		Dip soldering		No. of solders
	Soldering surface temperature	Heating time	Soldering temperature	Soldering time	
RKJXT1F, RKJXM	100°C max.	2 min. max.	260±5°C	5±1s	2 time max.
RKJXL	120°C max.	70s max.	260°C max.	6s max.	2 time max.

Example of Reflow Soldering Condition

1. Heating method: Double heating method with infrared heater.
2. Temperature measurement: Thermocouple $\phi 0.1$ to 0.2 CA (K) or CC (T) at soldering portion (copper foil surface).
A heat resisting tape should be used for fixed measurement.
3. Temperature profile

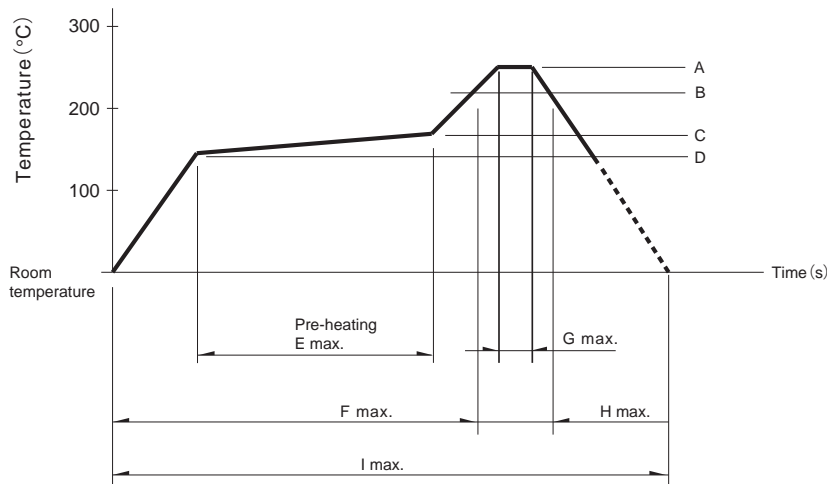

Series	A	B	C	D	E	F	G	H	I	No. of reflows
SLLB5	250°C	230°C	150°C	150°C	—	2 min.	—	30s	—	1 time
SLLB, SRBE	260°C	230°C	180°C	150°C	2 min.	—	—	40s	—	1 time
SKRH	260°C	230°C	180°C	150°C	2 min.	—	3s	40s	3-4 min.	2 times

Notes

1. The above temperature shall be measured on the mounting surface of a PC board. There are cases where the PC board's temperature greatly differs from that of the switch, depending on the material, size thickness of PC boards and others. The above-stated conditions shall also apply to switch surface temperatures.
2. Soldering conditions differ depending on reflow soldering machines. Prior verification of soldering condition is highly recommended.

Mouser Electronics

Authorized Distributor

Click to View Pricing, Inventory, Delivery & Lifecycle Information:

[Alps Alpine:](#)

[RKJXL100401V](#)